

# COLORFLEX SPECTRUM DMX FLEXISTRIP



## Product Features

<b>Color/CCT</b>	RGB + 5000K
<b>Input Voltage</b>	24 VDC
<b>Power Consumption</b>	18 W/m (5.49 W/ft)
<b>Ingress Protection (IP) Rating</b>	IP20
<b>Dimming Protocol</b>	RGBW DMX Controller
<b>Color Rendering Index (CRI)</b>	80+
<b>PCB Width</b>	10 mm (3/8 in)
<b>Cut Segment</b>	100 mm (4 in)
<b>Max Serial Run</b>	5 m (16 ft)
<b>Beam Angle</b>	120°
<b>Operational Temperature</b>	Operating Temperature: -20°C (-4°F) to 60°C (140°F)
<b>Key Design Features</b>	DMX Addressable for Animated Lighting Control
<b>Certifications</b>	CE, RoHS, ETL
<b>Lifespan</b>	50,000 Hours
<b>DMX Chip Model</b>	UCS512H4L

## ORDERING CODE

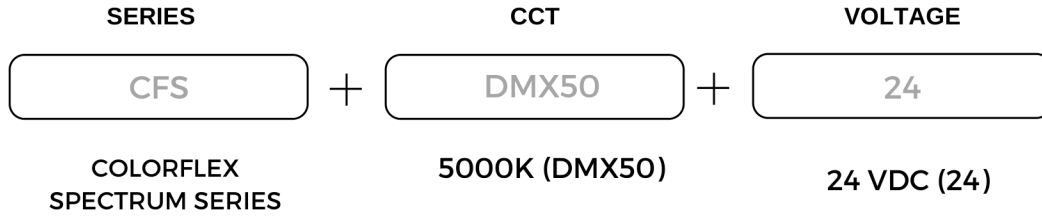

\*If a CCT is not available please advise our Sales Team and we can customize any required CCT. Previous customised CCT included 2200K, 2400K, 2700K and 10000K.

## Product Specifications

SKU	Lumens	Luminous Efficiency	CRI
CFS-DMX50-24	745 lm/m	90 lm/W	80

## PRODUCT DIMENSIONS

### ColorFlex Spectrum DMX: 24 VDC Model

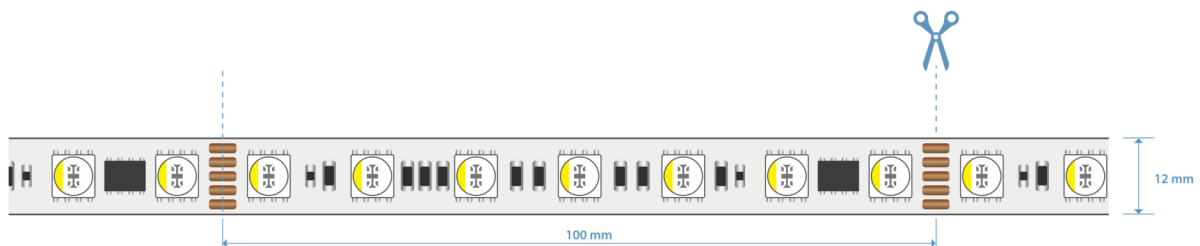

# FLEXISTRIP ACCESSORIES

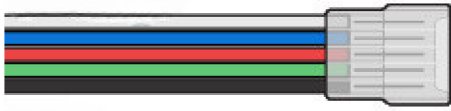

**SKU:** 5PC12

**PART NAME:** 12mm 5-Pin Press Down Quick Connector

**APPLICATION:** Non-Commercial Installations

**LIMITATIONS:** 5A

## Solderless Connection Guide

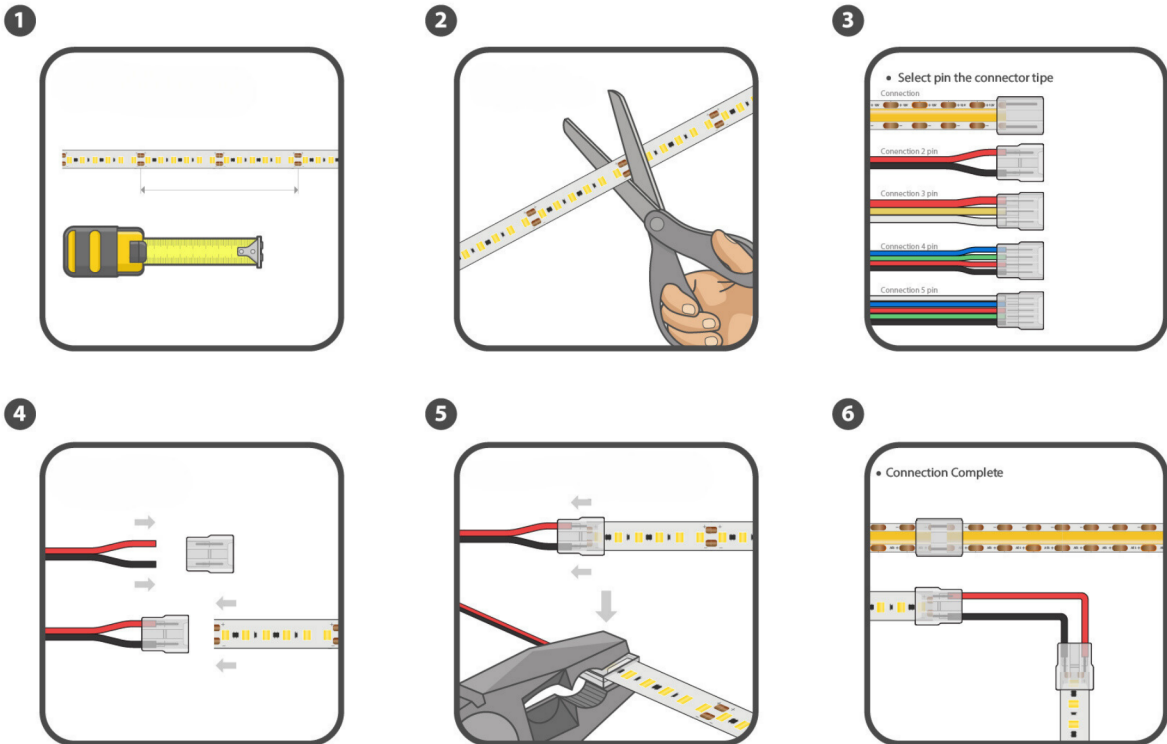

## POWER SUPPLIES

### Plug-In Power Supply



**PART NAME:** Power Supply Adaptor Series  
Input: 120-240 VAC, 50/60 Hz, US Plug Type

**SKU:**  
A601260 (60W 12V Model)  
A92496 (96W 24V Model)

### Hardwire Power Supply Indoor



**PART NAME:** Power Supply Slim Series  
Input: 120-240 VAC, 50/60 Hz

**SKU:**

S1220 (20W 12V Model)	S2420 (20W 24V Model)
S1230 (30W 12V Model)	S2430 (30W 24V Model)
S1240 (40W 12V Model)	S2440 (40W 24V Model)

### Hardwire Power Supply Outdoor



**PART NAME:** Power Supply Meanwell LPV Series  
Input: 90-264 VAC, 50/60 Hz

**SKU:**

LPV1260 (60W 12V Model)	LPV2460 (60W 24V Model)
LPV12100 (100W 12V Model)	LPV24100 (100W 24V Model)

### Switching Power Supply



**PART NAME:** Power Supply Switching LRS Series  
Input: 120-240 VAC, 50/60 Hz

**SKU:**

LRS12150 (150W 12V Model)	LRS24150 (150W 24V Model)
LRS12200 (200W 12V Model)	LRS24200 (200W 24V Model)
LRS12350 (350W 12V Model)	LRS24350 (350W 24V Model)



# VOLTAGE DROP GUIDE

## 12 VDC Single Color LED Flexistrip

Wattage	AWG 10	AWG 12	AWG 14	AWG 16	AWG 18	AWG 20	AWG 22
<b>20 W</b>	70.1 m (230 ft)	44.2 m (145 ft)	27.7 m (91 ft)	17.3 m (57 ft)	11 m (36 ft)	7 m (23 ft)	4.2 m (14 ft)
<b>40 W</b>	35.6 m (117 ft)	22.2 m (73 ft)	13.7 m (45 ft)	8.8 m (29 ft)	5.4 m (18 ft)	3.3 m (11 ft)	2.1 m (7 feet)
<b>60 W</b>	23.7 m (78 ft)	14.3 m (47 ft)	9.1 m (30 ft)	5.7 m (19 ft)	3.6 m (12 ft)	2.1 m (7 ft)	1.2 m (4 ft)
<b>80 W</b>	19.8 m (65 ft)	12.1 m (40 ft)	7.6 m (25 ft)	4.8 m (16 ft)	3 m (10 ft)	1.8 m (6 ft)	1.2 m (4 ft)
<b>100 W</b>	13.7 m (45 ft)	8.8 m (29 ft)	5.4 m (18 ft)	3.3 m (11 ft)	2.1 m (7 ft)	1.2 m (4 ft)	0.9 m (3 ft)

\*Calculations are based 8% voltage drop to 11 VDC.

## 24 VDC Single Color LED Flexisrip

Wattage	AWG 10	AWG 12	AWG 14	AWG 16	AWG 18	AWG 20	AWG 22
<b>20 W</b>	274.3 m (900 ft)	182.8 m (600 ft)	121.9 m (400 ft)	76.2 m (250 ft)	45.7 m (150 ft)	22.8 m (75 ft)	15.2 m (50 ft)
<b>40 W</b>	137.1 m (450 ft)	91.4 m (300 ft)	61 m (200 ft)	36.5 m (120 ft)	21.3 m (70 ft)	13.7 m (45 ft)	9.1 m (30 feet)
<b>60 W</b>	91.4 m (300 ft)	59.4 m (195 ft)	36.5 m (120 ft)	23.1 m (76 ft)	14.6 m (48 ft)	9.1 m (30 ft)	5.8 (19 ft)
<b>80 W</b>	70.1 m (230 ft)	44.2 m (145 ft)	27.4 m (90 ft)	17.3 m (57 ft)	11 m (36 ft)	7 m (23 ft)	4 m (13 ft)
<b>100 W</b>	56 m (184 ft)	35.3 m (116 ft)	22.2 m (73 ft)	14 m (46 ft)	8.8 m (29 ft)	5.7 m (19 ft)	3.3 m (11 ft)

\*Calculations are based 8% voltage drop to 22 VDC.

### Example:

Wattage	AWG 10	AWG 12	AWG 14	AWG 16	AWG 18
<b>20 W</b>	70.1 m (230 ft)	44.2 m (145 ft)	27.7 m (91 ft)	17.3 m (57 ft)	11 m (36 ft)
<b>40 W</b>	35.6 m (117 ft)	22.2 m (73 ft)	13.7 m (45 ft)	8.8 m (29 ft)	5.4 m (18 ft)
<b>60 W</b>	23.7 m (78 ft)	14.3 m (47 ft)	9.1 m (30 ft)	5.7 m (19 ft)	3.6 m (12 ft)

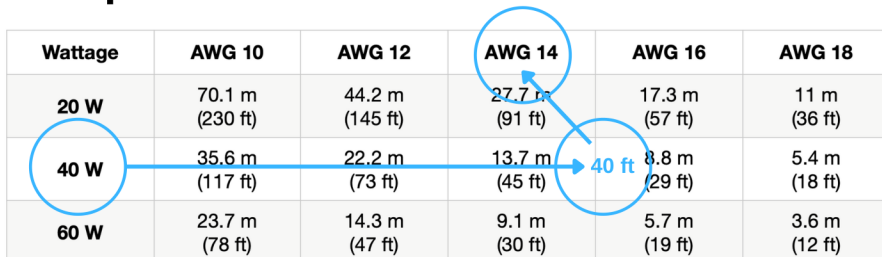

This voltage drop chart estimates the appropriate wire gauge to use based on power consumption (watts) and distance to the luminary. Use the charts above to identify the recommended wire gauge by finding the intersection of the rounded up wattage of your LED luminary and the distance to your power supply. *Note that these charts give an estimation and final calculations must be verified by an engineer or a licensed electrician.*

# WIRELESS CONTROLLERS

## DMX Decoder



**SKU:CLSDMX4C**  
**PART NAME: RGBW DMX**  
 Decoder 20A

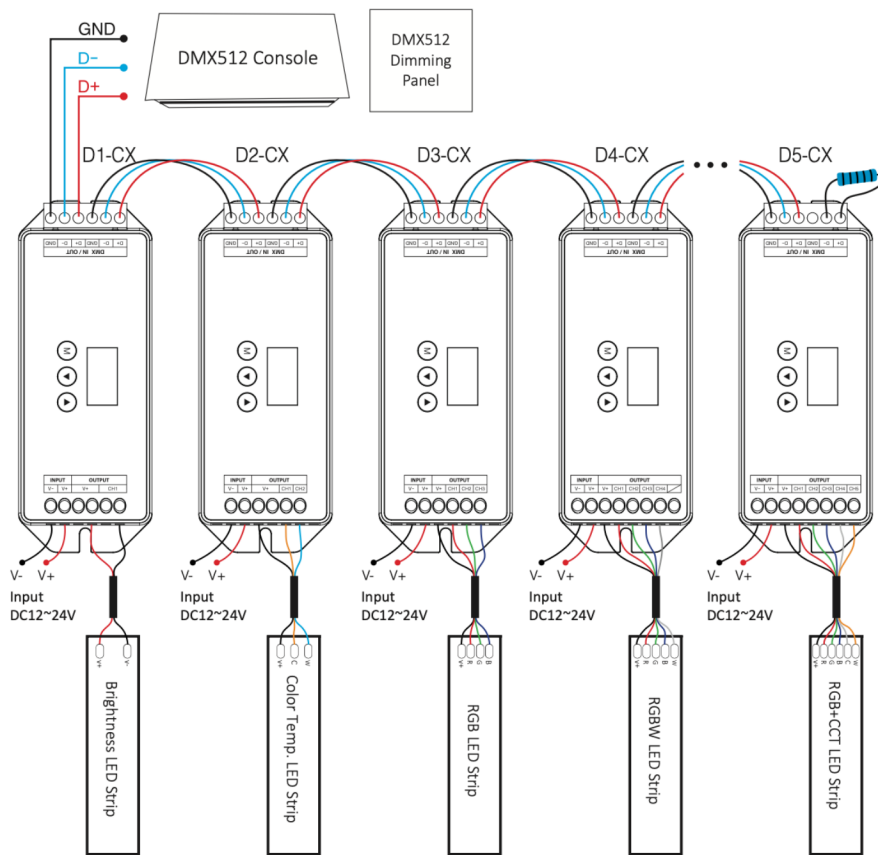

# WIRING DIAGRAMS

## DMX Decoder Wiring

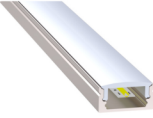
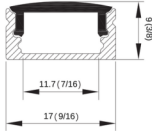
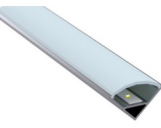
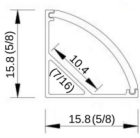
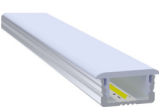
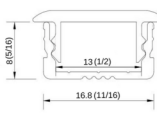

\*LED Power Supply not shown.

# LED EXTRUSION PROFILES

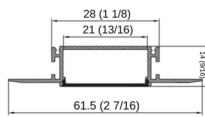
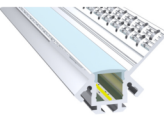
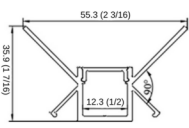
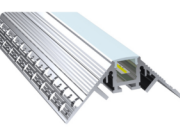
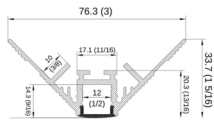
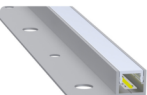
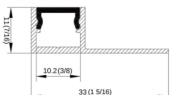
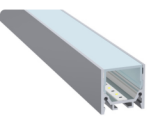
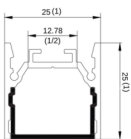
Image	Cross Section	Product	Mounting	SKU
		LumiTrack	Surface Mount or Recessed	LT-KIT-1M-S/W/B LT-KIT-2M-S/W/B
		LumiTrack 45	Surface Mount	LT45-KIT-1M-S/W/B LT45-KIT-2M-S/W/B
		LumiTrack Flange	Recessed	LTF-KIT-1M LTF-KIT-2M
		LumiTrack Trimless	Recessed	LTT-KIT-2M
		Phantom In	Recessed	PHANI-KIT-1M
		Phantom Out	Recessed	PHANO-KIT-1M
		Hardscape	Surface Mount or Recessed	HS-KIT-1M HS-KIT-2M
		Linea 1	Surface Mount, Recessed or Suspended	LIN1-KIT-1M-S/B/W LIN1-KIT-2MS/B/W

S - Silver Anodised Finish, B - Black Paint Finish, W - White Painted Finish

All LED Extrusion Profiles come with PMMA Frosted Diffuser (70% Light Transmittance), End Caps (2 pcs) and Mounting Clips (3 pcs per metre).

See LED Profiles Configuration Guide for assembly instructions.

# LED EXTRUSION PROFILES CONFIGURATION

## Surface Mounted Configuration

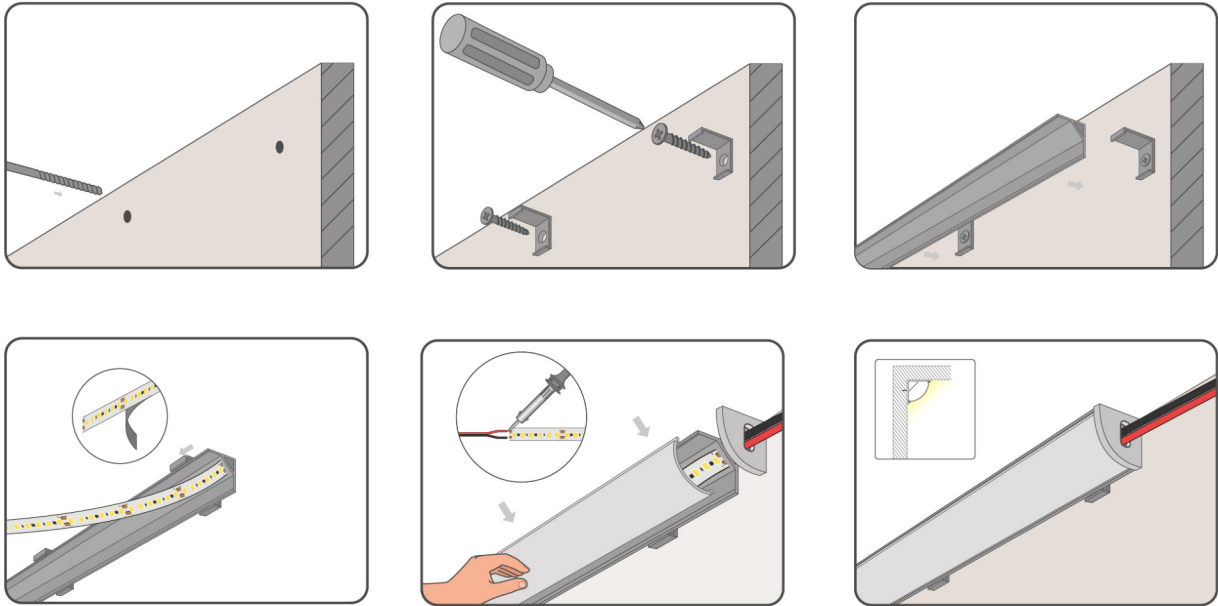

## Recessed Mounted Configuration

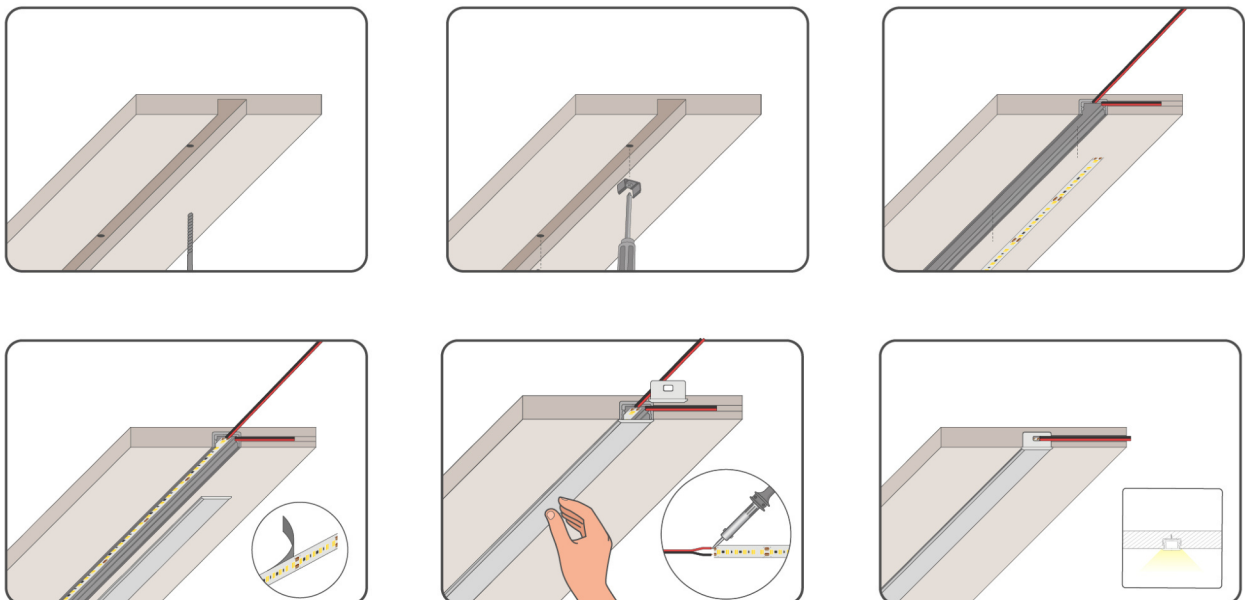

# LED EXTRUSION PROFILES CONFIGURATION

## Trimless Mounted Configuration

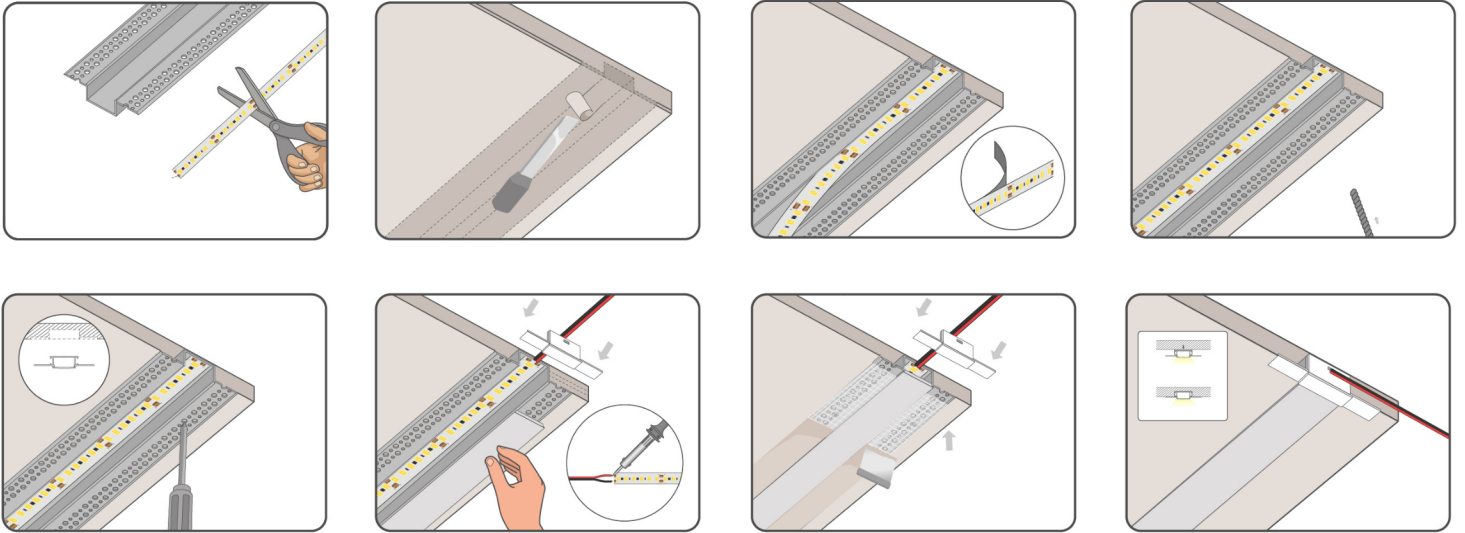





## Safety & Disclosures

---

1. Installation must be in accordance with local and national electrical code regulations.
2. To ensure safety and correct installation, our strips are intended to be installed by a qualified, licensed electrician.
3. Only install with a Class 2 DC Constant Voltage LED driver to meet UL requirements. 4. Do not install in an environment where excessive heat may exist.
5. LED strip lights must be handled with care. Excessive handling, bending, and pressure may damage the product, voiding the warranty.
6. Do not secure this product with any kind of staples, nails, or materials that could potentially damage the product in any way. Keep these instructions for future reference.
7. Do not cover this product with any kind of combustible material such as paper, fabrics, etc.
8. Each maximum run requires a dedicated power feed from the driver. Do not extend beyond the recommended maximum run length.
9. Make sure the appropriate gauge wire is installed between the driver, LEDs, and any dimmers. When choosing wire, calculate voltage drop, maximum amperage rating, and the location ratings on the wire. Improper wire selection and installation could overheat wires, and cause fire.
10. Do not modify the product beyond instructions or warranty will be void.
11. We reserve the right to modify and improve the design of our fixtures without prior notice. Although we try our best to order the same colors every time, due to changes in technology and phosphors over time, we cannot guarantee to match existing installed fixtures for subsequent orders or replacements in regards to product appearance, CCT, or lumen output.
12. Do not install product with the majority of the product unsupported. Allowing the product to be suspended or dangling while installing may cause damage to the PCB due to the weight of the strip and/or spool.

## Warranty

---

Caribbean LED Solutions hereby warrants that the products manufactured and/or distributed by us are merchantable and free from defects in material and workmanship and in conformity with standard specifications. The specifications referred to are the individual product guidelines. Materials and components are covered by limited warranty from the date of purchase for a period of three (3) year unless specified in our invoice description.

Our warranty shall not apply to normal wear and tear or in the event products are damaged as a result of misuse, abuse, neglect, accident, improper application, modification or repair and attachments to the product not approved by us. These factors will nullify the warranty:

- Not using a line conditioner or surge protector to connect dimmable LEDs.
- Caribbean LED Solutions will need to confirm this is connection before a warranty is issued.
- Not using voltage regulated supply to connect LEDs product or controls where specified.
- Connecting dimmers to non-dimmable LEDs
- Overloading a power supply.
- Operating LEDs out of specified working hours (Example: Using a residential grade LED in a commercial setting)
- Improper connection of power supplies, LED products or controls.
- Use of product in hot environments with poor ventilation.
- Use of product in enclosed fixtures with poor ventilation.
- Use of Non-wet location LEDs in wet/moist areas.
- Electrical surges or low-voltage.
- Faulty electrical installations.
- Acts of God.

Caribbean LED Solutions Limited shall have the right to inspect any products claimed as a defective product at the buyer's premises, or require the buyer to return the product to us for inspection at our premises.

Our exclusive remedy for a defective product that fails under normal use will be repaired or replaced with a comparable product at no cost for the replacement product.



☎ 868 235 4257 (4LED)

🌐 [www.caribbeanledsolutions.com](http://www.caribbeanledsolutions.com)

✉ [hello@caribbeanledsolutions.com](mailto:hello@caribbeanledsolutions.com)